



# ICI

---

INFRARED CAMERAS INC

## APEX 200 & APEX 300 QUICK START GUIDE

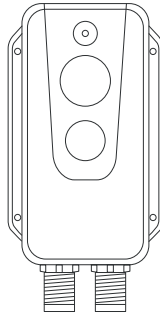

ICI cameras fall under US Federal Law and Export Control.

2105 W. Cardinal Dr. Beaumont, TX 77705  
Phone: (409) 861-0788  
Toll Free: (866) 861-0788  
infraredcameras.com  
support@infraredcameras.com  
We Are IR™

©Copyright 2021-2024, Infrared Cameras, Inc. - All rights reserved. The contents of this document may not be reproduced in whole or in parts without the written consent of the copyright owner.

Printed in the United States of America.

2105 W. Cardinal Dr.  
Beaumont, TX 77705  
(866) 861-0788  
[www.infraredcameras.com](http://www.infraredcameras.com)

Revision: 07-2024-001

THE MANUFACTURER RESERVES THE RIGHT TO ALTER THE SPECIFICATIONS OF THE PRODUCT WITHOUT PRIOR NOTIFICATION. THE MANUFACTURER ALLOWS HIMSELF THE RIGHT TO MODIFY WITHOUT ANY PRELIMINARY OPINION THE TECHNICAL SPECIFICATIONS OF THE PRODUCT. THIS MANUAL MAY CONTAIN TECHNICAL INACCURACIES OR TYPOGRAPHICAL ERRORS.

NOTICE ALL STATEMENTS, INFORMATION, AND RECOMMENDATIONS IN THIS MANUAL ARE BELIEVED TO BE ACCURATE BUT ARE PRESENTED WITHOUT WARRANTY OF ANY KIND. NOTWITHSTANDING ANY OTHER WARRANTY HEREIN, ALL DOCUMENT FILES AND SOFTWARE ARE PROVIDED "AS IS" WITH ALL FAULTS. ICI DISCLAIMS ALL WARRANTIES, EXPRESSED OR IMPLIED, INCLUDING, WITHOUT LIMITATION, THOSE OF MERCHANTABILITY, FITNESS FOR A PARTICULAR PURPOSE AND NON-INFRINGEMENT OR ARISING FROM A COURSE OF DEALING, USAGE, OR TRADE PRACTICE.

THE SOFTWARE LICENSE AND LIMITED WARRANTY FOR THE ACCOMPANYING PRODUCT ARE SET FORTH IN THE INFORMATION PACKET THAT SHIPPED WITH THE PRODUCT AND ARE INCORPORATED HEREIN BY THIS REFERENCE. IF YOU ARE UNABLE TO LOCATE THE SOFTWARE LICENSE OR LIMITED WARRANTY, CONTACT YOUR ICI REPRESENTATIVE FOR A COPY.

IN NO EVENT SHALL ICI BE LIABLE FOR ANY INDIRECT, SPECIAL, CONSEQUENTIAL, OR INCIDENTAL DAMAGES, INCLUDING, WITHOUT LIMITATION, LOST PROFITS OR LOSS OR DAMAGE TO DATA ARISING OUT OF THE USE OR INABILITY TO USE THIS MANUAL, EVEN IF ICI HAS BEEN ADVISED OF THE POSSIBILITY OF SUCH DAMAGES.

## Package Includes

---

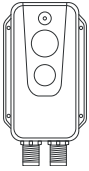

APEX Device

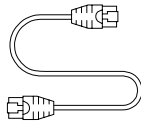

Ethernet Cable

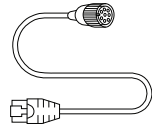

POE Ethernet Cable

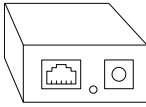

PoE Injector

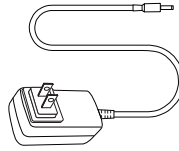

Power Adapter



M2 Screws x8

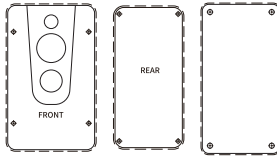

Alignment Guides



ST2.2 Screws x8

**ENSURE ALL SYSTEM EQUIPMENT AND COMPONENT ITEMS ARE PRESENT BEFORE BEGINNING INSTALLATION**

## Option 1: Rear Housing Installation

---

**USE THE ALIGNMENT GUIDES TO DRILL HOLES FOR SETTING DEVICE SCREWS.**

**DO NOT USE TOO LONG SCREWS WHEN INSTALLING THE FRONT/ REAR MOUNTING BRACKET. USING SCREWS THAT ARE TOO LONG MAY DAMAGE THE THERMAL CAMERA.**

**A.**

Place the rear facing alignment guide on the mounting position and drill four  $\Phi 2.5$  mounting holes according to the markers on the alignment guide.

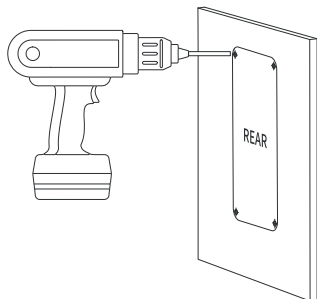

**B.**

Mount the device with four M2 screws.

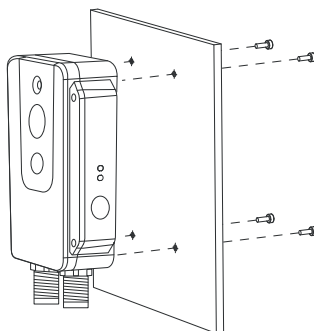

**THE THERMAL DEVICE WILL ACCUMULATE HEAT DURING OPERATION. ICI RECOMMENDS MOUNTING THE THERMAL DEVICE TO METALLIC OBJECTS AT ITS REAR HOUSING WHICH CAN REDUCE DEVICE HEATING AS WELL AS DECREASE THE TEMPERATURE DRIFT OF THE DETECTOR.**

C.

Align the 8-pin connector of the POE Ethernet cable to the 8-pin receptor on the device; then, plug in the cable.

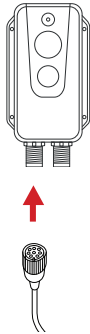

D.

Rotate the securing nut to the right to lock cable in place. Rotate the securing nut to the left to unlock the cable.

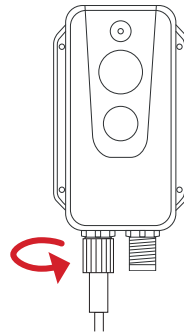

**ALIGN THE PINS BEFORE TRYING TO CONNECT THE POE ETHERNET CABLE. DO NOT FORCE THE POE ETHERNET CABLE ONTO THE DEVICE. FORCING THE CABLE ONTO THE DEVICE MAY RESULT IN DAMAGE TO THE PINS.**

**ALTERNATIVELY, POWER CAN BE PROVIDED THROUGH THE 12-PIN CONNECTOR VIA A 12-PIN CABLE (NOT PROVIDED).**

E.

Plug the Ethernet end of the POE Ethernet cable into the back of the PoE injector.

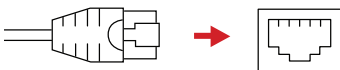

F.

Plug the jack end of the power adapter into the front of the PoE injector.

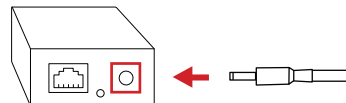

G.

Plug the power adapter into a 110/120V electrical outlet.

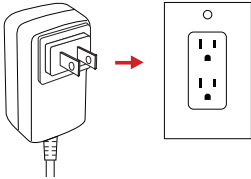

H.

Plug one end of the Ethernet cable into the front of the PoE injector.

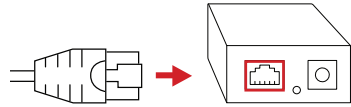

I.

Plug the other end of the Ethernet cable into the back of the network router.

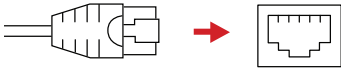

J.

Power on device.



**THE THERMAL IMAGER NEEDS SUFFICIENT WARM-UP TIME FOR THE MOST ACCURATE TEMPERATURE MEASUREMENTS AND BEST IMAGE QUALITY. THIS TIME CAN OFTEN VARY BY ENVIRONMENTAL CONDITIONS. IT IS BEST TO WAIT A MINIMUM OF 10 MINUTES FOR THE DEVICE TO COMPLETELY WARM-UP.**

K.

Connect to the device through an Internet browser.

## Option 2: Front Housing Installation

**USE THE ALIGNMENT GUIDES TO DRILL HOLES FOR SETTING DEVICE SCREWS.**

**DO NOT USE TOO LONG SCREWS WHEN INSTALLING THE FRONT/REAR MOUNTING BRACKET. USING SCREWS THAT ARE TOO LONG MAY DAMAGE THE THERMAL CAMERA.**

**A.**

Place the front facing alignment guide on the mounting position and drill four  $\Phi 2.5$  mounting holes according to the markers on the alignment guide.

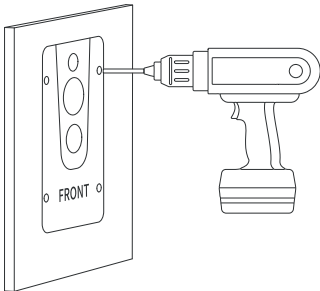

**B.**

Mount the device with four ST2.2 self-tapping screws.

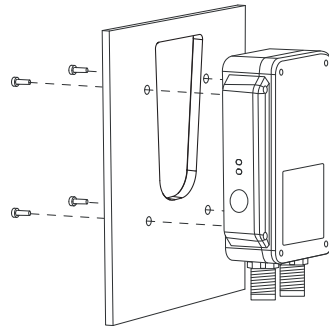

**THE THERMAL DEVICE WILL ACCUMULATE HEAT DURING OPERATION. ICI RECOMMENDS MOUNTING THE THERMAL DEVICE TO METALLIC OBJECTS AT ITS REAR HOUSING WHICH CAN REDUCE DEVICE HEATING AS WELL AS DECREASE THE TEMPERATURE DRIFT OF THE DETECTOR.**

C.

Align the 8-pin connector of the POE Ethernet cable to the 8-pin receptor on the device; then, plug in the cable.

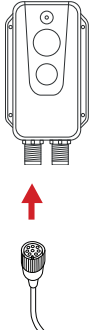

D.

Rotate the securing nut to the right to lock cable in place. Rotate the securing nut to the left to unlock the cable.

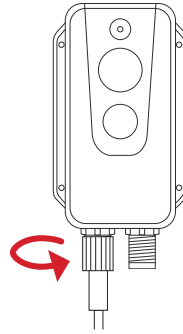

**ALIGN THE PINS BEFORE TRYING TO CONNECT THE POE ETHERNET CABLE. DO NOT FORCE THE POE ETHERNET CABLE ONTO THE DEVICE. FORCING THE CABLE ONTO THE DEVICE MAY RESULT IN DAMAGE TO THE PINS.**

**ALTERNATIVELY, POWER CAN BE PROVIDED THROUGH THE 12-PIN CONNECTOR VIA A 12-PIN CABLE (NOT PROVIDED).**

E.

Plug the Ethernet end of the POE Ethernet cable into the back of the PoE injector.

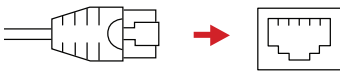

F.

Plug the jack end of the power adapter into the front of the PoE injector.

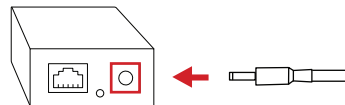



G.

Plug the power adapter into a 110/120V electrical outlet.

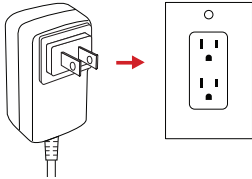

H.

Plug one end of the Ethernet cable into the front of the PoE injector.

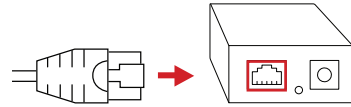

I.

Plug the other end of the Ethernet cable into the back of the network router.

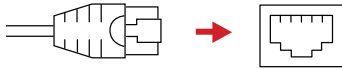

J.

Power on device.



**THE THERMAL IMAGER NEEDS SUFFICIENT WARM-UP TIME FOR THE MOST ACCURATE TEMPERATURE MEASUREMENTS AND BEST IMAGE QUALITY. THIS TIME CAN OFTEN VARY BY ENVIRONMENTAL CONDITIONS. IT IS BEST TO WAIT A MINIMUM OF 10 MINUTES FOR THE DEVICE TO COMPLETELY WARM-UP.**

K.

Connect to the device through an Internet browser.

## About ICI / Contact

---

Infrared Cameras, Inc.  
2105 W. Cardinal Dr.  
Beaumont, TX 77705

Phone: (409) 861-0788 | Toll Free: (866) 861-0788 | International: (409) 861-0788

General Inquiry: [support@infraredcameras.com](mailto:support@infraredcameras.com)

Website: [www.infraredcameras.com](http://www.infraredcameras.com)

You may reach a representative by phone or email Mon – Fri 8:00AM – 5:00PM CST.

ICI manufactures complete systems and software. We can provide complete engineering, software, and OEM solutions. Our Fortune 500 clients rely on us for infrared equipment and thermography training (which we offer through the Infrared Training Institute).

In addition to providing custom germanium, silica, and sapphire optics, we also build windows for enclosures, as well as custom pan and tilt units. We can even provide customizable explosion-proof systems.

Our knowledge and experience stems from years of using infrared imaging and temperature measurement instruments to provide solutions to: managers, engineers, scientists, inspectors and operators in space, power companies, medical, pulp and paper, food industry, research and development, and various process industries. You can see our products and services used in industrial, commercial, and government applications worldwide. Originally named Texas Infrared (still DBA), Infrared Cameras, Inc. has been in business since March, 1995.

Thank you for your dedicated and continued support.