



# ICI

---

**INFRARED CAMERAS** INC

## **CORONA CAMERA** **QUICK START GUIDE**

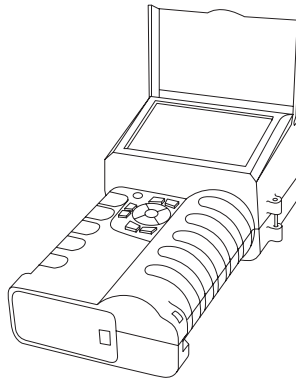

ICI cameras fall under US Federal Law and Export Control.

2105 W. Cardinal Dr. Beaumont, TX 77705  
Phone: (409) 861-0788  
Toll Free: (866) 861-0788  
infraredcameras.com  
support@infraredcameras.com  
We Are IR™

©Copyright 2023, Infrared Cameras, Inc. - All rights reserved. The contents of this document may not be reproduced in whole or in parts without the written consent of the copyright owner.

Printed in the United States of America.

2105 W. Cardinal Dr.  
Beaumont, TX 77705  
(866) 861-0788  
[www.infraredcameras.com](http://www.infraredcameras.com)

Revision: 07.2023-001

THE MANUFACTURER RESERVES THE RIGHT TO ALTER THE SPECIFICATIONS OF THE PRODUCT WITHOUT PRIOR NOTIFICATION. THE MANUFACTURER ALLOWS HIMSELF THE RIGHT TO MODIFY WITHOUT ANY PRELIMINARY OPINION THE TECHNICAL SPECIFICATIONS OF THE PRODUCT. THIS MANUAL MAY CONTAIN TECHNICAL INACCURACIES OR TYPOGRAPHICAL ERRORS.

NOTICE ALL STATEMENTS, INFORMATION, AND RECOMMENDATIONS IN THIS MANUAL ARE BELIEVED TO BE ACCURATE BUT ARE PRESENTED WITHOUT WARRANTY OF ANY KIND. NOTWITHSTANDING ANY OTHER WARRANTY HEREIN, ALL DOCUMENT FILES AND SOFTWARE ARE PROVIDED "AS IS" WITH ALL FAULTS. ICI DISCLAIMS ALL WARRANTIES, EXPRESSED OR IMPLIED, INCLUDING, WITHOUT LIMITATION, THOSE OF MERCHANTABILITY, FITNESS FOR A PARTICULAR PURPOSE AND NONINFRINGEMENT OR ARISING FROM A COURSE OF DEALING, USAGE, OR TRADE PRACTICE.

THE SOFTWARE LICENSE AND LIMITED WARRANTY FOR THE ACCOMPANYING PRODUCT ARE SET FORTH IN THE INFORMATION PACKET THAT SHIPPED WITH THE PRODUCT AND ARE INCORPORATED HEREIN BY THIS REFERENCE. IF YOU ARE UNABLE TO LOCATE THE SOFTWARE LICENSE OR LIMITED WARRANTY, CONTACT YOUR ICI REPRESENTATIVE FOR A COPY.

IN NO EVENT SHALL ICI BE LIABLE FOR ANY INDIRECT, SPECIAL, CONSEQUENTIAL, OR INCIDENTAL DAMAGES, INCLUDING, WITHOUT LIMITATION, LOST PROFITS OR LOSS OR DAMAGE TO DATA ARISING OUT OF THE USE OR INABILITY TO USE THIS MANUAL, EVEN IF ICI HAS BEEN ADVISED OF THE POSSIBILITY OF SUCH DAMAGES.

## Package Includes

---

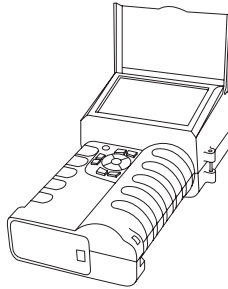

Corona Camera

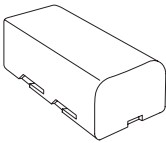

Battery x2

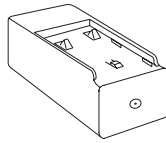

Battery Charger

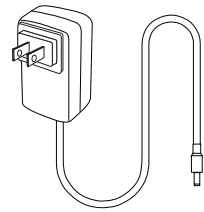

Power Adapter

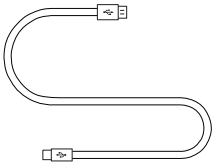

USB to Type-C Cable

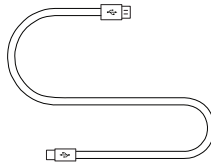

Micro USB to USB



Memory Card

**ENSURE ALL SYSTEM EQUIPMENT AND COMPONENT ITEMS ARE PRESENT BEFORE BEGINNING INSTALLATION**

# Set Up

---

## A.

Mount the fully charged Corona Camera to a tripod using the 1/4"-20 mount located on the back of the device handle.

The Corona Camera can be used as a handheld device.

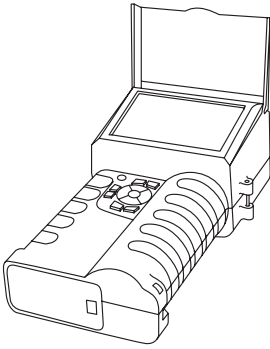

or

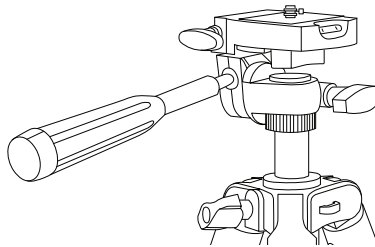
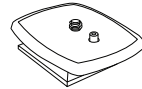
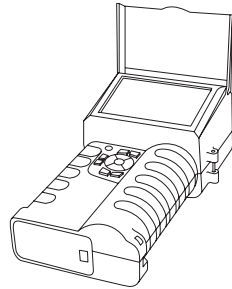

**MAKE SURE TRIPODS DO NOT BLOCK THE DIRECT PATH OF PERSON(S) TO BE IMAGED TO ENSURE THE EQUIPMENT WILL NOT BE MOVED OR KNOCKED DOWN. USING A DIVIDING BARRIER WILL HELP KEEP TRIPODS SEPARATE FROM THE PATH.**

**TURN ON THE CAMERA BY PRESSING AND HOLDING THE POWER BUTTON FOR AT LEAST TWO SECONDS.**

**B.**

Power on device.

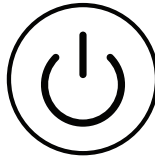

**PRESS AND HOLD THE POWER BUTTON FOR MORE THAN 5 SECONDS TO SHUT DOWN THE CAMERA.**

**THE THERMAL IMAGER NEEDS SUFFICIENT WARM-UP TIME FOR THE MOST ACCURATE TEMPERATURE MEASUREMENTS AND BEST IMAGE QUALITY. THIS TIME CAN OFTEN VARY BY ENVIRONMENTAL CONDITIONS. IT IS BEST TO WAIT A MINIMUM OF 10 MINUTES FOR THE DEVICE TO COMPLETELY WARM-UP.**

# Battery Installation

**MAKE SURE TO HOLD THE CAMERA FIRMLY IN BOTH HANDS WHEN REMOVING OR REPLACING BATTERY OR ATTACHING OR REMOVING THE BATTERY BAY COVER.**

**A.**

Press and hold the battery bay button and lift upwards to open the battery bay cover.

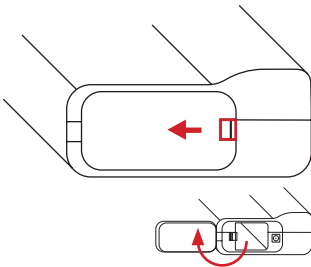

**B.**

Ensure metal contacts are aligned, then push battery into battery bay.

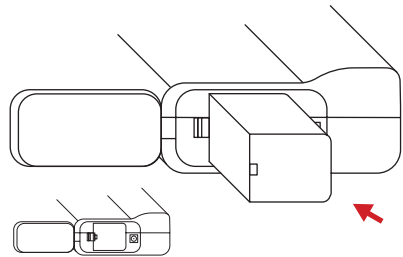

**C.**

To replace a battery held in the battery bay push the battery buckle. Battery will be ejected.

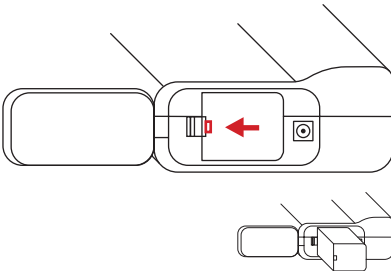

**D.**

Close lid.

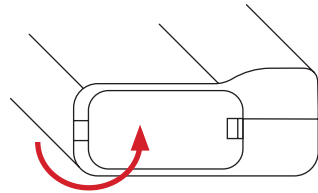

**DO NOT FORCE THE BATTERY INTO THE BATTERY BAY. IF USER FEELS SIGNIFICANT RESISTANCE REMOVE THE BATTERY AND ENSURE METAL CONTACTS ARE ALIGNED BEFORE TRYING TO PLACE BATTERY INTO THE BATTERY BAY.**

# Memory Card

---

A.

Insert the Memory Card into the side of the Corona Camera device until a clicking sound is heard.

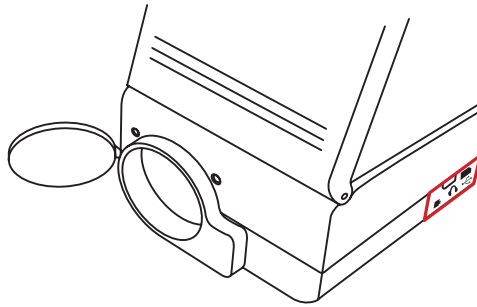

**DO NOT FORCE MICRO-SD CARD INTO THE SLOT. THE SIDE OF THE CARD WITH CONTACT PINS MUST BE INSERTED FIRST. IF THERE IS RESISTANCE FLIP THE CARD AROUND AND TRY AGAIN. TO EJECT THE MEMORY CARD PRESS UNTIL A CLICK IS HEARD AND THEN RELEASE. MEMORY CARD WILL BE EJECTED.**

# Charging Instructions: Option 1

---

A.

While a battery is inside the device, plug the power adapter into the battery bay jack slot of the Corona Camera device.

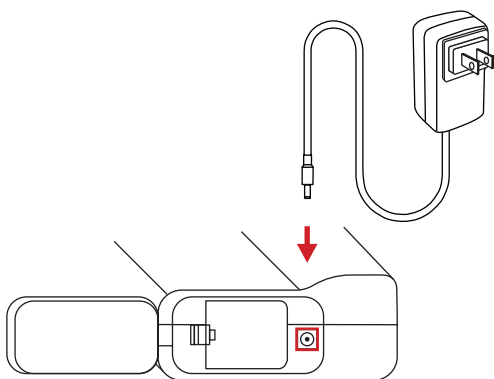

D.

Plug power adapter into a 110/120V electrical outlet.

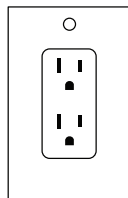

**WHEN THE BATTERY BAY IS EMPTY THE INDICATOR SHOWS GREEN. THE LIGHT TURNS RED WHEN THE BATTERY IS PLACED AND CHARGING. WHEN THE BATTERY IS FULLY CHARGED THE LIGHT TURNS GREEN.**

**ICI DOES NOT RECOMMEND CHARGING THE DEVICE WHILE IT IS ON A TRIPOD. LAY DEVICE FACE DOWN ON A FLAT AND STABLE DESK OR TABLE WHILE CHARGING.**

**ENSURE THE IMAGER IS NEAR ROOM TEMPERATURE BEFORE CHARGING THE DEVICE. DO NOT CHARGE IN EXTREMELY HOT OR COLD AREAS. THE BATTERY CAPACITY MAY BE DECREASED IF CHARGED IN AN EXTREME TEMPERATURE ENVIRONMENT.**

**IF YOU DO NOT USE THE IMAGER FOR A LONG PERIOD OF TIME, PUT THE DEVICE IN A COOL AND DRY ENVIRONMENT. THE BATTERY WILL DISCHARGE OVER TIME; THEREFORE, THE IMAGER SHOULD BE CHARGED OCCASIONALLY TO PREVENT DAMAGE TO THE BATTERY OR THE DEVICE.**



## Charging Instructions: Option 2

REMOVE THE BATTERIES FROM THE DEVICE TO FOLLOW CHARGING METHOD.

A.

Plug the power adapter into the battery charger.

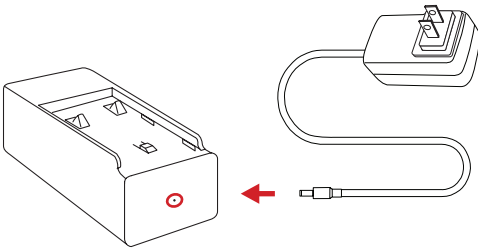

B.

Insert batteries into battery charger.

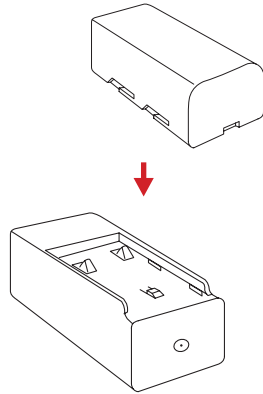

D.

Plug power adapter into a 110/120V electrical outlet.

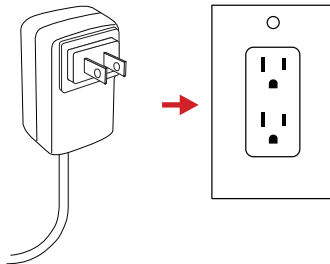

**WHEN THE BATTERY IS NOT PLACED IN THE CHARGER THE INDICATOR LIGHT DOES NOT FLASH. THE LIGHT TURNS RED WHEN THE BATTERY IS PLACED AND CHARGING. WHEN THE BATTERY IS FULLY CHARGED THE LIGHT TURNS GREEN.**

## About ICI / Contact

---

Infrared Cameras, Inc.  
2105 W. Cardinal Dr.  
Beaumont, TX 77705

Phone: (409) 861-0788 | Toll Free: (866) 861-0788 | International: (409) 861-0788

General Inquiry: [support@infraredcameras.com](mailto:support@infraredcameras.com)

Website: [www.infraredcameras.com](http://www.infraredcameras.com)

You may reach a representative by phone or email Mon – Fri 8:00AM – 5:00PM CST.

ICI manufactures complete systems and software. We can provide complete engineering, software, and OEM solutions. Our Fortune 500 clients rely on us for infrared equipment and thermography training (which we offer through the Infrared Training Institute).

In addition to providing custom germanium, silica, and sapphire optics, we also build windows for enclosures, as well as custom pan and tilt units. We can even provide customizable explosion-proof systems.

Our knowledge and experience stems from years of using infrared imaging and temperature measurement instruments to provide solutions to: managers, engineers, scientists, inspectors and operators in space, power companies, medical, pulp and paper, food industry, research and development, and various process industries. You can see our products and services used in industrial, commercial, and government applications worldwide. Originally named Texas Infrared (still DBA), Infrared Cameras, Inc. has been in business since March, 1995.

Thank you for your dedicated and continued support.